



## REQUEST FOR QUOTATION

Mindoro State University (MinSU) Main Campus through Bids and Awards Committee will undertake **Small Value Procurement** pursuant to the provisions of R.A. 12009, to wit;

<b>Name of Project</b>	IMPROVEMENT OF ACADEMIC FACILITY (OLD DEFTAC) AT MINSU CALAPAN CITY CAMPUS
<b>Solicitation</b>	RFQ 2026-0017
<b>Place of Delivery</b>	MINSU CALAPAN CAMPUS
<b>Brief Description</b>	IMPROVEMENT OF ACADEMIC FACILITY (OLD DEFTAC) AT MINSU CALAPAN CITY CAMPUS
<b>Quantity</b>	One (1) Lot
<b>Approved Budget for the Contract (ABC)</b>	Php 1,038,735.44
<b>Date of Delivery</b>	29 days upon conformed of Notice to Proceed

Please quote your **lowest price** on the attached bid form and submit personally/through email your **SEALED QUOTATION** not later than on 9:00am on MAY 12 2026 at the **Bids and Awards Committee (BAC) Office, Mindoro State University -Main Campus, Alcate, Victoria, Oriental Mindoro.**

Received by:

Name and Signature: \_\_\_\_\_

Company: \_\_\_\_\_

Date: \_\_\_\_\_

  
**ROVELYN P. ROXAS**  
 BAC Chairperson

### Terms and Conditions:

1. All entries must be **LEGIBLE**.
2. Delivery Period within \_\_\_\_ calendar days.
3. Warranty shall be for a period of six (6) months for supplies and materials, one (1) year for Equipment, from date of acceptance by the procuring entity.
4. Price validity shall be a period of 30 calendar days.
5. PhilGEPS Registration Certificate shall be attached upon submission of the Quotation.
6. Bidders shall submit Original Brochures showing certification of the product being offered (Required; if applicable).
7. Mode of delivery: [  ] Pick-up (Schedule) [  ] Door to Door Delivery



## BID FORM

Item/s and Specification/s (minimum)	Unit	Qty.	Brand / Specification	Unit Price (VAT inclusive)	Total Amount (VAT inclusive)	Compliance with Technical Specifications (please check)	
						YES	NO
B.5 – Project Billboard/ Sign Board	ea.	1.00				( )	( )
B.7 – Occupational Safety & Health Program	months	1.00				( )	( )
101 – Structural Works	lot	1.00				( )	( )
102 – Dry Wall	sq.m.	475.40				( )	( )
103 – Painting Works	sq.m.	246.00				( )	( )
104 – Roofing Works	sq.m.	308.00				( )	( )
<b>**nothing follows**</b>							
<b>TOTAL</b>							

### General Conditions

1. Quotations and other requirements stated below shall be submitted to the **Bids and Awards Committee (BAC) Office, Mindoro State University -Main Campus, Alcate, Victoria, Oriental Mindoro**, Philippines on the date and time stated in this RFP.

2. Supplier shall submit the following requirements:

- ( ) Duly signed original copy of Request for Quotation (RFQ). Prices shall be quoted in
- ( ) Notarized Omnibus Sworn Statement (if above 200k as lot basis)
- ( ) PhilGEPS Platinum Certificate of Registration (**only if Platinum Certificate**) (Valid, updated and Active and no expired document listed on the last page) with CTC
- ( ) Brochure (if Goods and Equipment) (Updated & Original or CTC)
- ( ) PCAB License( if infrastructure)(Updated & Original or CTC)



( ) BIR certificate of Registration (BIR 2303)(Updated & Original or CTC)

**Please submit if the PhilGEPS Registration is RED**

- ( ) PhilGEPS proof of Red Registration (Updated & Original or CTC)
- ( ) DTI/SEC/CDA Registration (Updated & Original or CTC)
- ( ) Business/ Mayor's Permit (Updated & Original or CTC)
- ( ) Tax Clearance/ Tax Compliance Verification Cert (Updated & Original or CTC) if Php 500,000 above
- ( ) Latest Income / Business Tax Return (Updated & Original or CTC)
- ( ) Audited Financial Statement (Updated & Original or CTC)

**Note: Please ensure that all non-original documents, including those submitted via email or in person, are duly certified as true copies (CTC) and bear the name and signature of the authorized representative. Failure to comply with this requirement may result in disqualification.**

**Price validity shall be 30 calendar days from the deadline of submission of quotation.**

### Ocular Inspection

The supplier and its premises **may be subjected to ocular inspection or verification** by the End-User and/or the BAC Technical Working Group (TWG), **if deemed necessary to confirm compliance with technical specifications prior to award.**

### Award

The contract shall be awarded to the supplier who:

1. Submitted the **Lowest Calculated and Responsive Bid (LCRB)**; and
2. Successfully **passed verification of compliance with eligibility, technical requirements, and, if applicable, ocular inspection or post-qualification** performed by the TWG.

Award is **subject to the approval of the Head of the Procuring Entity** and is **conditional upon compliance with all requirements** under RA 12009, the GPPB guidelines, and the RFQ. If the supplier with the LCRB **fails verification or inspection**, the BAC may consider the **next lowest responsive bid**.

### Evaluation of Quotations

Quotations shall be compared and evaluated based on:

1. Completeness of Submission of all required documents
2. Compliance with Item & Description Requirements
3. Reasonableness and competitiveness of the quoted price, evaluated based on the **LCRB/HRRB/MEARB/MARB** in relation to the Approved Budget for the Contract (ABC).

### Instructions



1. Supplier shall be responsible for the source(s) of its goods/services/equipment, and which shall be in accordance with the schedule and specifications of the RFQ and contract. Failure of the supplier to comply with this provision shall be ground for cancellation of the award or purchase order issued to the supplier.
2. Supplier that accepted an award, purchase order, or contract but failed to deliver the required goods/services/equipment within the time called for in the award, purchase order, and contract shall be disqualified from participating in MinSU or any of MinSU campuses future procurement activities. This is without prejudice to the imposition of other sanctions prescribed under R.A. 9184 and its IRR-A against the supplier.
3. The supplier is responsible for **all duties, excise, taxes, and other government charges**.
4. All transactions are subject to withholding of creditable government taxes in accordance with the revenue regulation(s) of the Bureau of Internal Revenue

## Document transmission service

The supplier shall shoulder the courier expenses for the delivery of documents such as the **Notice of Award (NOA), Purchase Order (PO), Contract Agreement (CA), Notice to Proceed (NTP)** and **other related documents pertaining to the supplier**.

## Liquidation Damages

A penalty of one-tenth of one percent (0.001) **of the total contract price per calendar day** shall be imposed for any delay in the delivery of goods, services, or equipment. The total liquidated damages **shall not exceed 10% of the total contract price**. Exceeding this threshold **shall constitute a ground for termination of the contract by the BAC**.

## Warranty

The supplier warrants that all goods, services, or equipment **conform to acceptable industry standards** and the specifications stated in the RFQ and contract. Any defect or non-conformance discovered during the warranty period shall be remedied by the supplier at no additional cost.

## Payment

Payment shall be made only upon a certification by the Head of the Procuring Entity to the effect that the GOODS have been rendered, delivered or installed in accordance with the terms of this Contract and have been duly inspected and accepted by the

\_\_\_\_\_



# MINDORO STATE UNIVERSITY

Victoria, Oriental Mindoro 5205 Philippines

✉ universitypresident@minsu.edu.ph

🌐 www.minsu.edu.ph

☎ +63 977 846 72 28



*After having carefully read and accepted your Terms and Conditions. I/We quote you on the item at prices noted above.*

Printed Name of authorized representative/Signature \_\_\_\_\_

Position: \_\_\_\_\_

Name of Company \_\_\_\_\_

Address: \_\_\_\_\_ Email Address: \_\_\_\_\_

Fax No. \_\_\_\_\_, Tel No.: \_\_\_\_\_ Cellphone No. \_\_\_\_\_

Date: \_\_\_\_\_

LBP Account No. of Establishment: \_\_\_\_\_

Name of Payee: \_\_\_\_\_

Tax Identification Number: \_\_\_\_\_

Copy of PhilGEPS Registration No.: \_\_\_\_\_

BIR Registration:  VAT  Non-VAT

Canvassed by:

**FLORENCE F. BUENO**

Canvasser

Contact Number: 0936-946-9634

Email Address: bac.office@minsu.edu.ph



Webometrics

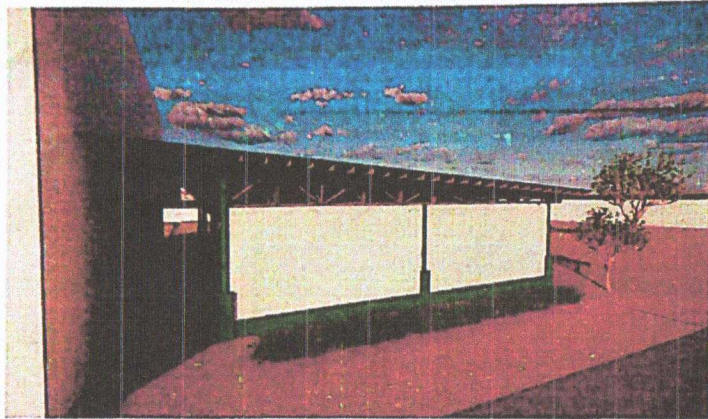

PERSPECTIVE  
N T S

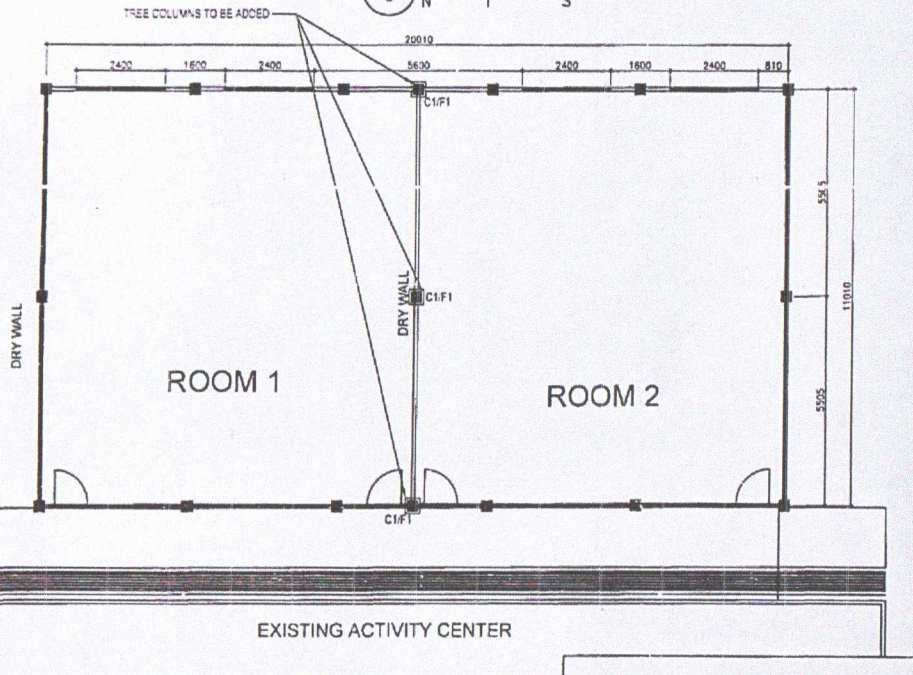

FLOOR PLAN  
N T S

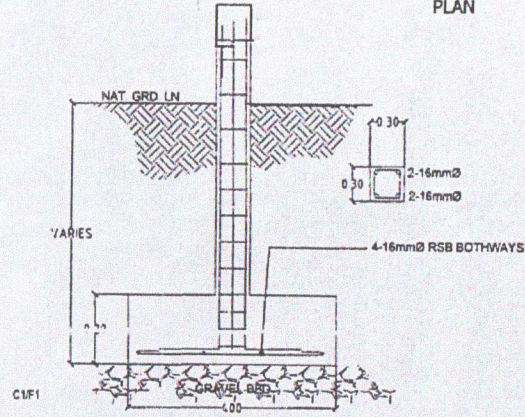
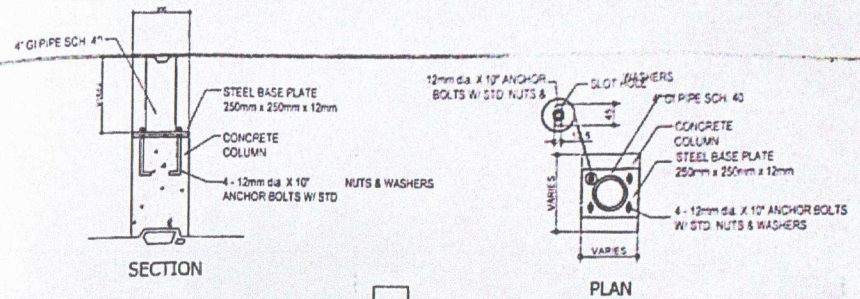

COLUMN & FOOTING DETAIL  
N T S

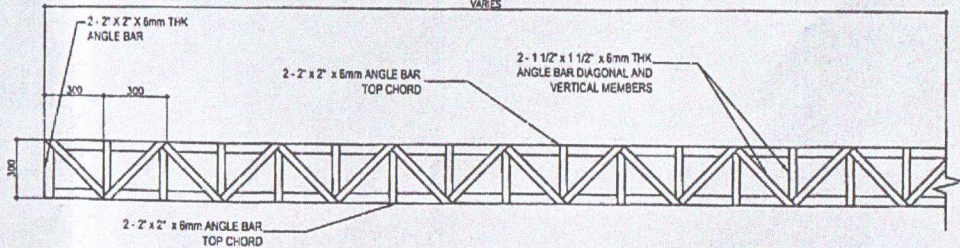

ROOF BEAM DETAIL  
N T S

	<b>Project Owner</b> <b>MINDORO STATE UNIVERSITY</b> Location: MAIN CAMPUS	<b>Project Title</b> I.A. 9386, Art 1, Sec 20 Drawings and Specifications duly signed, stamped or sealed as instruments of service, are the intellectual properties and documents of the architect, whether the object for which they are made is executed or not. It shall be unlawful for any person, without the consent of the architect, or author of said documents for use in the repetition of and for other project or buildings, whether associated party or in whole.	<b>Prepared by</b> ENGR JOANNE FE M GUTIERREZ License: BRGY MASIPIT, CALAPAN, ORIENTAL MINDORO PROJECT DEVELOPMENT OFFICER II	<b>Checked and Approved by</b> ENGR MARK LESTER P MAGPANTAY PROJECT DEVELOPMENT OFFICER III	<b>Verified by</b> ENGR ARVIN P TOLENTINO DIRECTOR FOR AUXILIARY AND GENERAL SERVICES	<b>Recommending Approval</b> ROVELYN P ROXAS DIC-VP FOR ADMIN & FINANCE	<b>Approved by</b> ENYA MARIE D APOSTOL, Ph.D UNIVERSITY PRESIDENT	<b>Sheet no</b> <b>AS1</b>
	Project Title: IMPROVEMENT OF ACADEMIC FACILITY (OLD DEFTAC) AT MINSU CALAPAN CITY CAMPUS							

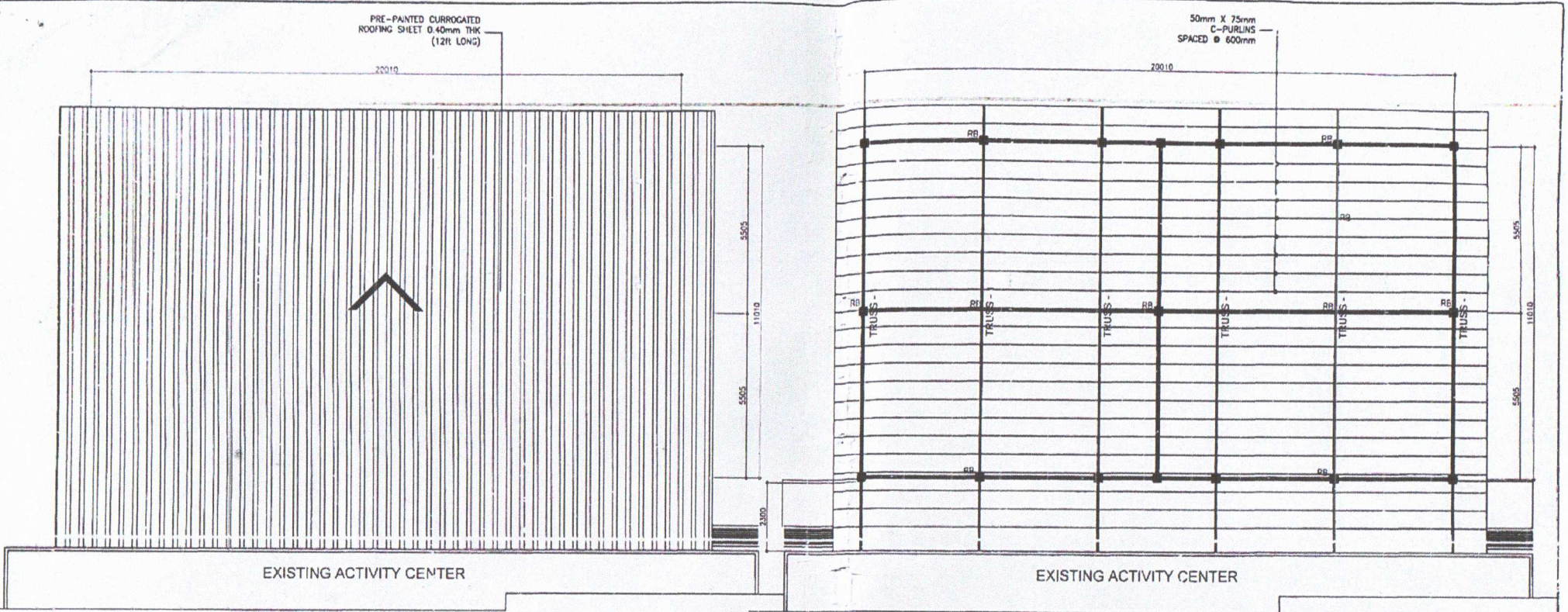

ROOF FRAMING PLAN

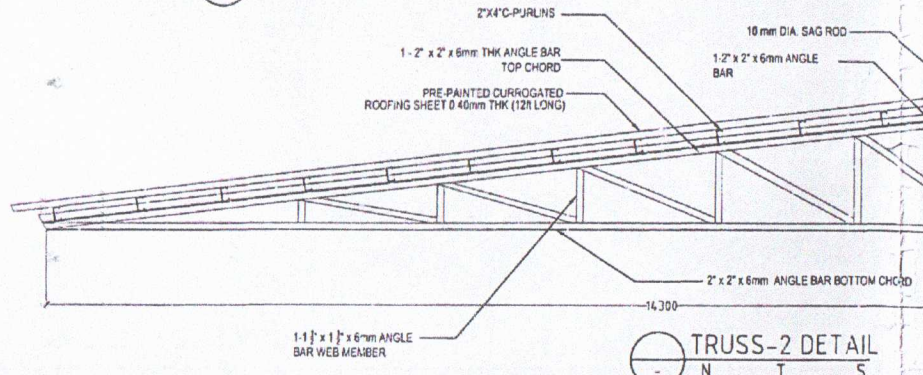

ROOF FRAMING PLAN

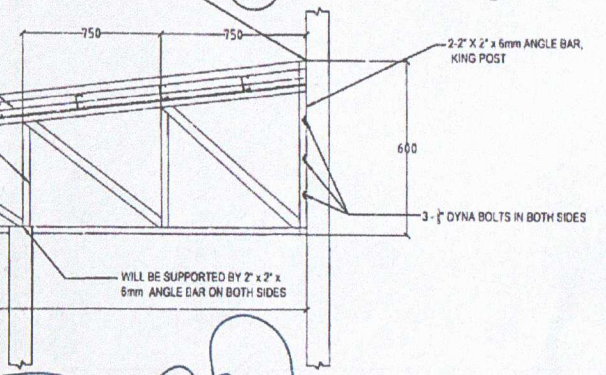

 <p><b>MINDORO STATE UNIVERSITY</b> MAIN CAMPUS</p>	<p>R.A. 8266, Art 3, Sec 28 Drawings and Specifications duly signed, stamped or sealed, as instruments of service, are the intellectual properties and documents of the architect, whether the signed for which they are made is executed or not. It shall be unlawful for any person, without the consent of the architect, or author of said documents for use in the repetition of and for other project or buildings, whether executed partly or in whole.</p>	<p>Project Title <b>IMPROVEMENT OF ACADEMIC FACILITY (OLD DEFTAC) AT MINSU CALAPAN CITY CAMPUS</b></p>	<p>Prepared by <b>ENGR. JOANNE FE M. GUTIERREZ</b></p>	<p>Checked/Reviewed by <b>ENGR. MARCESTERA MAGPANTAY</b></p>	<p>Verified by <b>ENGR. ARVIN P. TOLENTINO</b></p>	<p>Recommending approval <b>ROVELYN P. ROXAS</b></p>	<p>Approved by <b>ENYA MARIE D. APOSTOL, Ph.D.</b></p>	<p>Sheet No. <b>S2</b></p>
		<p>Location BROY MASPIT, CALAPAN, ORIENTAL MINDORO</p>	<p>PROJECT DEVELOPMENT OFFICER II</p>	<p>PROJECT DEVELOPMENT OFFICER III</p>	<p>DIRECTOR FOR AUXILIARY AND GENERAL SERVICES</p>	<p>OIC-VP FOR ADMIN &amp; FINANCE</p>	<p>UNIVERSITY PRESIDENT</p>	